

Demension

Brushless

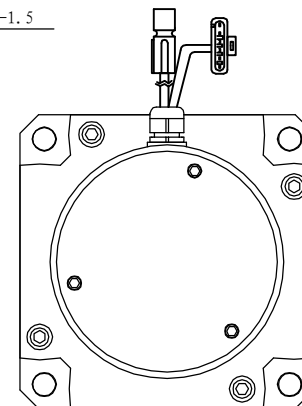

Motor to Hall Relationship

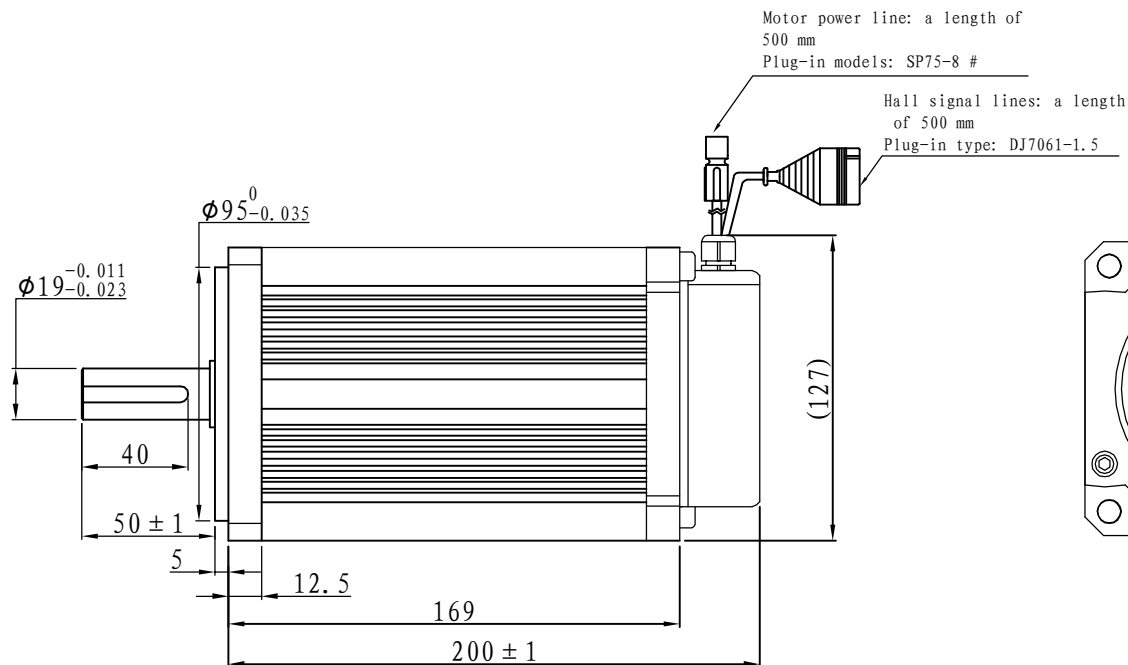
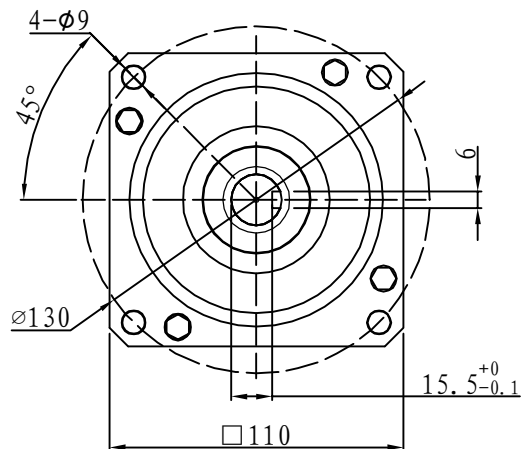
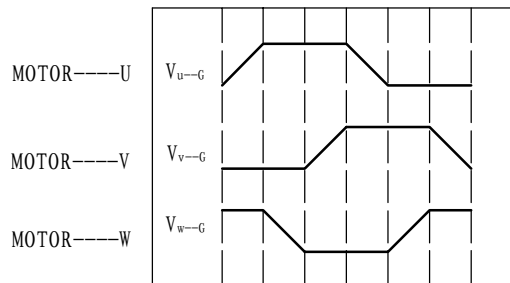
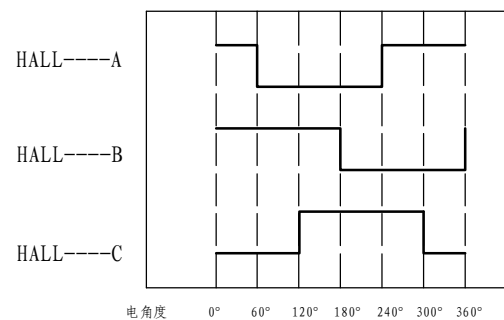

PHASE TO GROUND VOLTAGE
ROTATION CW FROM THE FLANGE

Line Define

Power Wire

Red	Motor U
Yellow	Motor V
Blue	Motor W

Feedback Wire

Hall line colour	Hall signal definition	Plug serial number
Orange and black	5V	1
Orange	0V	2
Yellow	Hall A	3
Blue	Hall B	4
Green	Hall C	5

Tecnichal Data

Type	110WD-M06030-48V
Power (KW)	1.8
Rated voltage (V)	48
Rated current (A)	44
Rated speed(rpm)	3000
Rated torque (NM)	6
Rotor inertia (Kgcm ²)	10
Protection rank	IP65
Insulation rank	F
Appropriate environment	Temperature: 0 ~ 50°C Humidity: < 90% (No dewdrop)
Motor weight (KG)	6.6