

Brushless

Demension

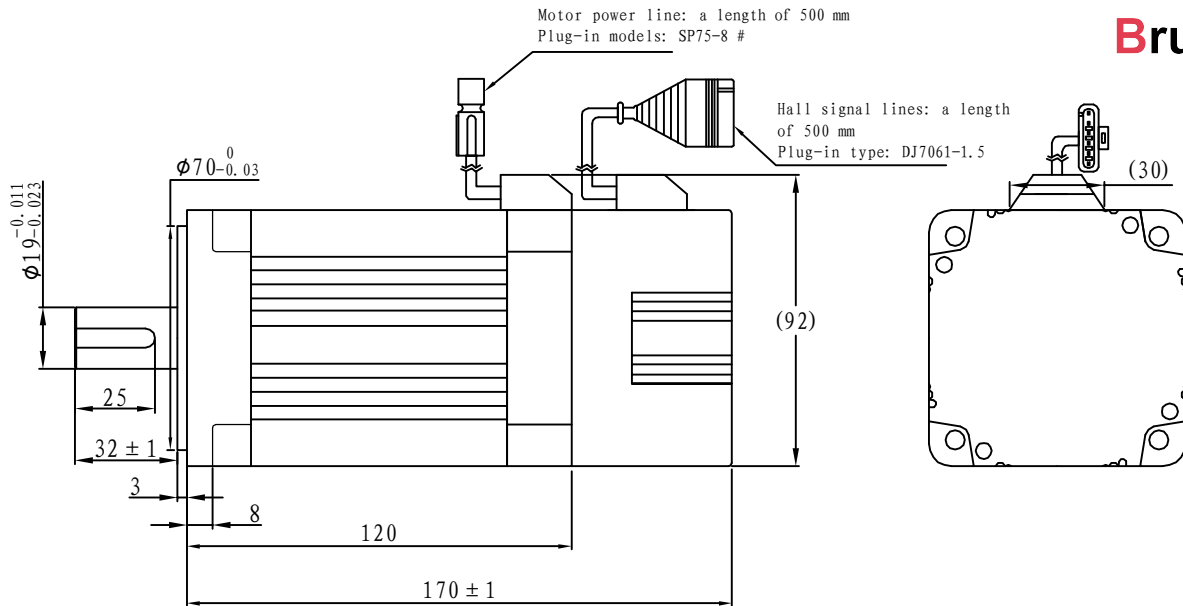

Motor to Hall Relationship

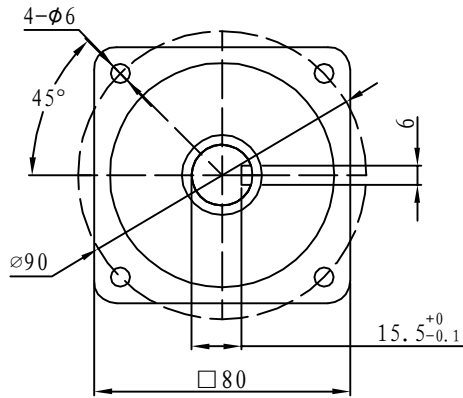
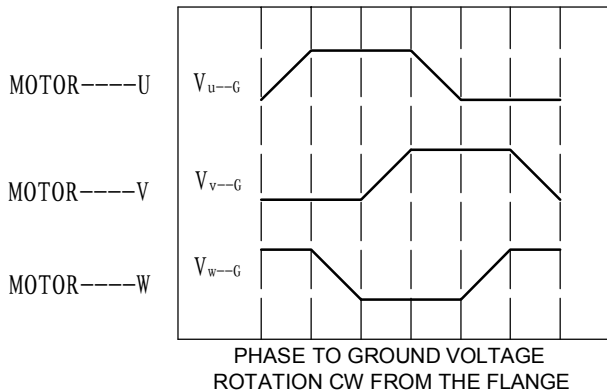
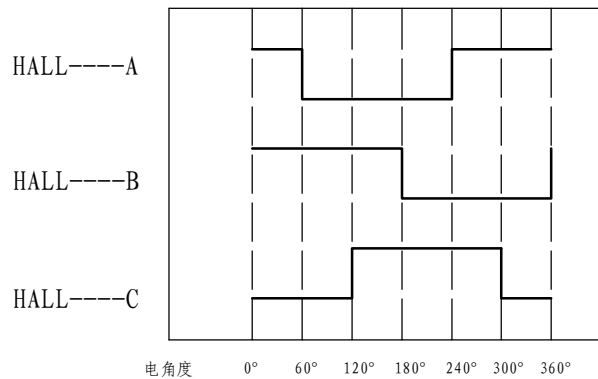

Line Define

Power Wire

Red	Motor U
Yellow	Motor V
Blue	Motor W

Feedback Wire

Hall line colour	Hall signal definition	Plug serial number
Orange and black	5V	1
Orange	0V	2
Yellow	Hall A	3
Blue	Hall B	4
Green	Hall C	5

Tecnichal Data

Type	80WD-M02430-96V
Power (KW)	0.75
Rated voltage (V)	96
Rated current (A)	9.82
Rated speed (rpm)	3000
Rated torque (NM)	2.4
Rotor inertia (Kgcm ²)	0.8
Protection rank	IP54
Insulation rank	F
Appropriate environment	Temperature: 0 ~ 50°C Humidity: <90% (No dewdrop)
Motor weight (KG)	3